



ECX®



REVENGE

1/8 ELECTRIC BUGGY TYPE e™

ECX04000

Congratulations on your purchase of the ECX® Revenge Type e™ Buggy. This 1/8-scale model introduces you to the sport of RC driving.

Herzlichen Glückwunsch zum Kauf des ECX Revenge Type e Buggy. Dieses 1/8 Scale Model öffnet Ihnen die Welt des RC Car Sports.

Nous vous félicitons pour l'achat du ECX Revenge Type e Buggy. Ce modèle 1/8 vous initie à la conduite RC.

Congratulazioni per l'acquisto di questo Revenge Type e Buggy ECX. Questa vettura in scala 1/8 vi introdurrà nel mondo dei modelli RC.

**INSTRUCTION MANUAL
BEDIENUNGSANLEITUNG
MANUEL D'UTILISATION
MANUALE DI ISTRUZIONI**

NOTICE

All instructions, warranties and other collateral documents are subject to change at the sole discretion of Horizon Hobby, LLC. For up-to-date product literature, visit <http://www.horizonhobby.com> and click on the support tab for this product.

Meaning of Special Language:

The following terms are used throughout the product literature to indicate various levels of potential harm when operating this product:

NOTICE: Procedures, which if not properly followed, create a possibility of physical property damage AND little or no possibility of injury.

CAUTION: Procedures, which if not properly followed, create the probability of physical property damage AND a possibility of serious injury.

WARNING: Procedures, which if not properly followed, create the probability of property damage, collateral damage, and serious injury OR create a high probability of superficial injury.



WARNING: Read the ENTIRE instruction manual to become familiar with the features of the product before operating. Failure to operate the product correctly can result in damage to the product, personal property and cause serious injury.

This is a sophisticated hobby product and NOT a toy. It must be operated with caution and common sense and requires some basic mechanical ability. Failure to operate this Product in a safe and responsible manner could result in injury or damage to the product or other property. This product is not intended for use by children without direct adult supervision. Do not use with incompatible components or alter this product in any way outside of the instructions provided by Horizon Hobby, LLC. This manual contains instructions for safety, operation and maintenance. It is essential to read and follow all the instructions and warnings in the manual, prior to assembly, setup or use, in order to operate correctly and avoid damage or serious injury.

Age Recommendation: Not for children under 14 years. This is not a toy.

Safety Precautions and Warnings

As the user of this product, you are solely responsible for operating in a manner that does not endanger yourself and others or result in damage to the product or property of others.

This model is controlled by a radio signal subject to interference from many sources outside your control. This interference can cause momentary loss of control, so it is advisable to always keep a safe distance in all directions around your model as this margin will help avoid collisions or injury.

- Never operate your model with low transmitter batteries.
- Always operate your model in an open area away from cars, traffic or people.
- Never operate the model in the street or in populated areas for any reason.
- Carefully follow the directions and warnings for this and any optional support equipment (chargers, rechargeable battery packs, etc.) you use.

- Keep all chemicals, small parts and anything electrical out of the reach of children.
- Never lick or place any portion of the model in your mouth as it could cause serious injury or even death.
- Exercise caution when using tools and sharp instruments.
- Take care during maintenance as some parts may have sharp edges.
- Immediately after using your model, do NOT touch equipment such as the motor, electronic speed control and battery, because they generate high temperatures. You may burn yourself seriously touching them.
- Do not put fingers or any objects inside rotating and moving parts, as this may cause damage or serious injury.
- Always turn on your transmitter before you turn on the receiver in the car. Always turn off the receiver before turning your transmitter off.
- Keep the wheels of the model off the ground when checking the operation of the radio equipment.



WARNING AGAINST COUNTERFEIT PRODUCTS: Always purchase from a Horizon Hobby, LLC authorized dealer to ensure authentic high-quality Spektrum product. Horizon Hobby, LLC disclaims all support and warranty with regards, but not limited to, compatibility and performance of counterfeit products or products claiming compatibility with DSM or Spektrum.

TABLE OF CONTENTS

| | | | |
|--|----------|--|-----------|
| Safety Precautions and Warnings | 2 | When You are Finished..... | 8 |
| Water-Resistant Vehicle with Waterproof Electronics | 3 | Motor Care | 8 |
| Specifications | 4 | Maintenance | 8 |
| Components | 4 | Setting the Gear Mesh..... | 8 |
| Vehicle Preparations | 4 | Electronic Speed Control (ESC)..... | 9 |
| Installing Transmitter Batteries | 4 | Shock Cleaning..... | 10 |
| Transmitter Battery Safety Precautions..... | 5 | Additional Maintenance Tips..... | 10 |
| Installing the Wing..... | 5 | Binding | 10 |
| Removing/Installing the Vehicle Body..... | 5 | Troubleshooting Guide..... | 11 |
| Installing the Battery in the Vehicle | 5 | Limited Warranty | 11 |
| Transmitter Controls..... | 6 | FCC Information..... | 13 |
| Power System | 6 | Compliance Information for the European Union | 13 |
| Getting Started..... | 7 | Replacement Parts | 50 |
| Operation..... | 7 | Parts Diagram..... | 54 |

WATER-RESISTANT VEHICLE WITH WATERPROOF ELECTRONICS

Your new Horizon Hobby vehicle has been designed and built with a combination of waterproof and water-resistant components to allow you to operate the product in many “wet conditions”, including puddles, creeks, wet grass, snow and even rain.

While the entire vehicle is highly water-resistant, it is not completely waterproof and your vehicle should NOT be treated like a submarine. The various electronic components used in the vehicle, such as the Electronic Speed Control (ESC), servo(s) and receiver are waterproof, however, most of the mechanical components are water-resistant and should not be submerged.

Metal parts, including the bearings, hinge pins, screws and nuts, as well as the contacts in the electrical cables, will be susceptible to corrosion if additional maintenance is not performed after running in wet conditions. To maximize the long-term performance of your vehicle and to keep the warranty intact, the procedures described in the “Wet Conditions Maintenance” section below must be performed regularly if you choose to run in wet conditions. If you are not willing to perform the additional care and maintenance required, then you should not operate the vehicle in those conditions.

 **CAUTION:** Failure to exercise caution while using this product and complying with the following precautions could result in product malfunction and/or void the warranty.

General Precautions

- Read through the wet conditions maintenance procedures and make sure that you have all the tools you will need to properly maintain your vehicle.
- Not all batteries can be used in wet conditions. Consult the battery manufacturer before use. Caution should be taken when using Li-Po batteries in wet conditions.
- Most transmitters are not water-resistant. Consult your transmitter’s manual or the manufacturer before operation.
- Never operate your transmitter or vehicle where lightning may be present.
- Do not operate your vehicle where it could come in contact with salt water (ocean water or water on salt-covered roads), contaminated or polluted water. Salt water is very conductive and highly corrosive, so use caution.
- Even minimal water contact can reduce the life of your motor if it has not been certified as water-resistant or waterproof. If the motor becomes excessively wet, apply very light throttle until the water is mostly removed from the motor. Running a wet motor at high speeds may rapidly damage the motor.
- Driving in wet conditions can reduce the life of the motor. The additional resistance of operating in water causes excess strain. Alter the gear ratio by using a smaller pinion or larger spur gear. This will increase torque (and motor life) when running in mud, deeper puddles, or any wet conditions that will increase the load on the motor for an extended period of time.

Wet Conditions Maintenance

- Drain any water that has collected in the tires by spinning them at high speed. With the body removed, place the vehicle upside down and pull full throttle for a few short bursts until the water has been removed.

 **CAUTION:** Always keep hands, fingers, tools and any loose or hanging objects away from rotating parts when performing the above drying technique.

- Remove the battery pack(s) and dry the contacts. If you have an air compressor or a can of compressed air, blow out any water that may be inside the recessed connector housing.
- Remove the tires/wheels from the vehicle and gently rinse the mud and dirt off with a garden hose. Avoid rinsing the bearings and transmission.

NOTICE: Never use a pressure washer to clean your vehicle.

- Use an air compressor or a can of compressed air to dry the vehicle and help remove any water that may have gotten into small crevices or corners.
- Spray the bearings, drive train, fasteners and other metal parts with a water-displacing light oil or lubricant. Do not spray the motor.
- Let the vehicle air dry before you store it. Water (and oil) may continue to drip for a few hours.
- Increase the frequency of disassembly, inspection and lubrication of the following:
 - Front and rear axle hub assembly bearings.
 - All transmission cases, gears and differentials.
 - Motor—clean with an aerosol motor cleaner and re-oil the bearings with lightweight motor oil.

SPECIFICATIONS

Transmitter

| | |
|------------|-------------------|
| Frequency | 2.4GHz |
| Modulation | DSM, DSM2, Marine |
| Battery | AA x 4 |

Servo

| | |
|-----------------|--------------------------------|
| Power Supply | 4.8V-6V (shared with receiver) |
| Output Torque | 199.8 oz-in (8.5 kg-cm) |
| Operating Speed | 0.20 sec/60 degrees of travel |
| Size | 55.6 x 18 x 30mm |

Electronic Speed Control (ESC)

| | |
|---------------------|----------------------|
| Input Voltage | 7.4-11.1V |
| Constant/Peak | 100 A/590 A |
| Resistance | 0.0045 Ohm |
| Overload Protection | Thermal |
| BEC Voltage | 6V/3 A |
| Size | 53.5mm x 36mm x 36mm |
| Weight | 79 g |

COMPONENTS

Included Items

1. ECX® Revenge Type e™ 1/8-scale Buggy
2. Spektrum™ DX2E transmitter
 - 3 degree rear toe set
 - Shock spacers
 - Turnbuckle wrench
 - L-wrenches: 1.5mm, 2mm, 2.5mm

Needed to Complete

- DYN4108 Prophet™ Sport Duo Li-Po 50Wx2 Dual Battery Charger
- Dynamite® Gold Series 2S or 3S Li-Po Battery



VEHICLE PREPARATIONS

INSTALLING TRANSMITTER BATTERIES

1. Slide the panel open on the bottom of the transmitter.
2. Obey the battery plus (+) and minus (-) diagram in the transmitter to install 4 AA batteries.
3. Slide the panel closed.

We recommend using only alkaline AA batteries in the transmitter, however, it is possible to use rechargeable Ni-MH batteries.

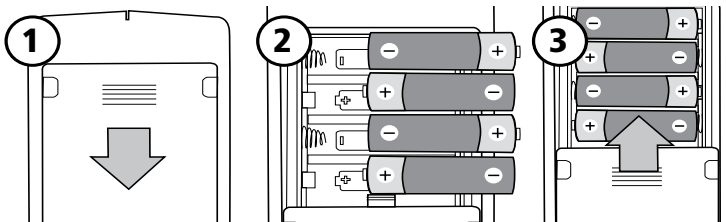

CAUTION: If using rechargeable batteries, charge only rechargeable batteries. Charging non-rechargeable batteries may cause the batteries to burst, resulting in injury to persons and/or damage to property.

TRANSMITTER BATTERY SAFETY PRECAUTIONS

- Never install damaged batteries.
- Never install batteries of mixed types or of different ages in the transmitter.
- Always remove exhausted batteries.
- Always remove batteries before storing the transmitter.
- Low battery power can result in loss of control of the RC vehicle.

INSTALLING THE WING

1. Remove the long wing clip from the wing mounts.
2. Align the holes in the wing with the wing mounts.
3. Press the wing onto the wing mounts.
4. Secure the wing by sliding the long wing clip through the wing mounts.



REMOVING/INSTALLING THE VEHICLE BODY

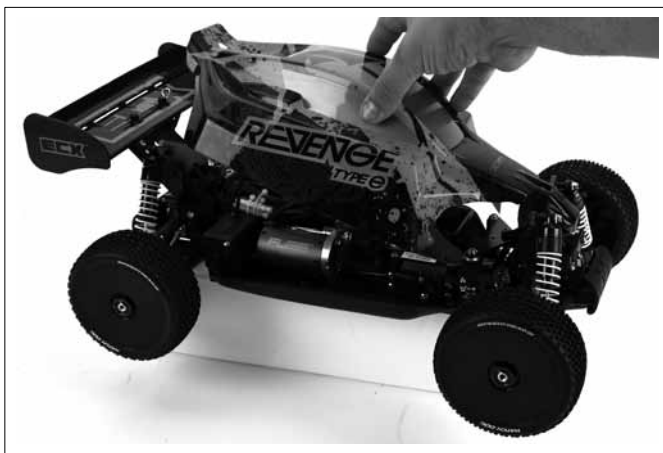

Removing

1. Remove the two body clips.
2. Pull off the body.

Installing

1. Install the body over the two body posts.
2. Install the two body clips.

INSTALLING THE BATTERY IN THE VEHICLE



1. Loosen the hook and loop straps.
2. Install a fully charged battery.
3. Tighten the hook and loop straps.

TRANSMITTER CONTROLS

Reverse Switch

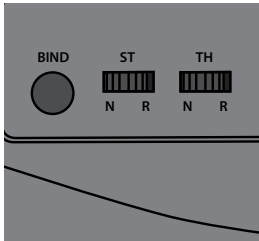

Allows you to change the direction of steering (ST. REV) and throttle (TH. REV) controls. (Default settings are "R" for steering and "N" for throttle)

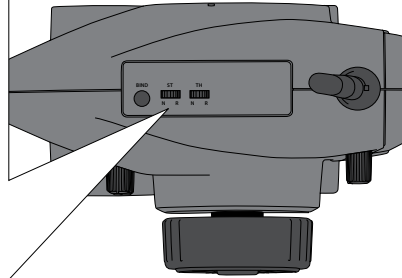

Steering Trim



Adjust to make the vehicle drive straight with no input at the steering wheel

Throttle Trim



Adjusts the neutral point of the electronic speed control

Steering Rate



Adjusts the amount the rudder moves when the steering wheel is turned left or right

Power Switch

Power on or off the transmitter

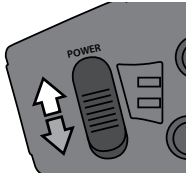



Steering Wheel



Controls steering. Right and Left steering with ST. REV Switch on R (See ST. REV switch)

Battery Level Indicator

-  Solid Green: Battery voltage is good (Above 4V)
-  Flashing Green: Battery voltage is critically low (below 4V). Replace batteries

Throttle Trigger

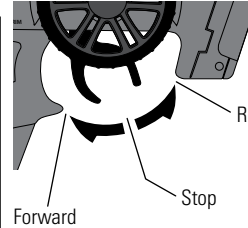

Controls power to the engine for forward or reverse (See TH. REV switch)

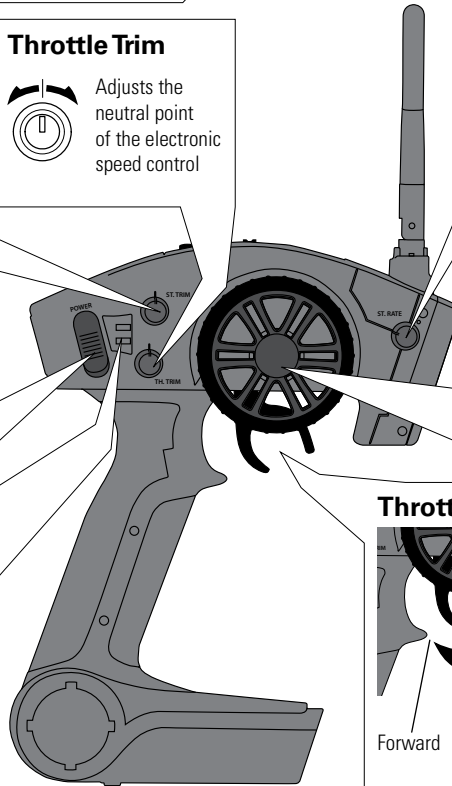

POWER SYSTEM

The ESC is capable of operating from 7.2 to 11.1V.
The included 550 size 4-pole 2500Kv motor is specifically developed and geared (16T) for use up to 11.1V (3S).

GETTING STARTED

1. Power on the transmitter.

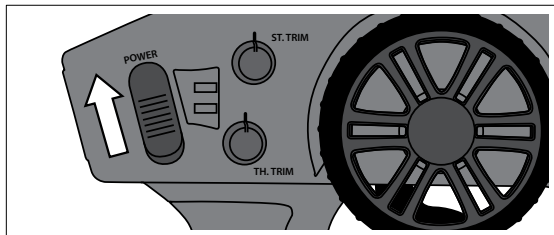

2. Connect the battery and turn on the ESC.

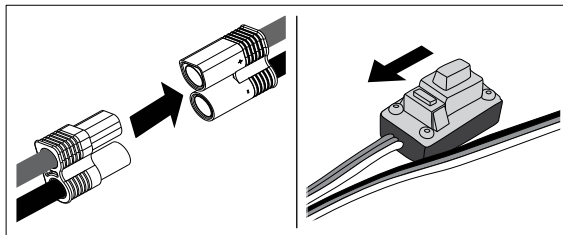

3. Do a test of the transmitter's control of the vehicle with the vehicle's wheels off the ground.

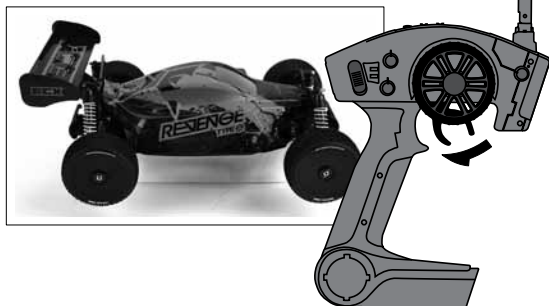

4. Start driving slowly, and, if the vehicle does not go straight, adjust the steering trim dial on the transmitter.

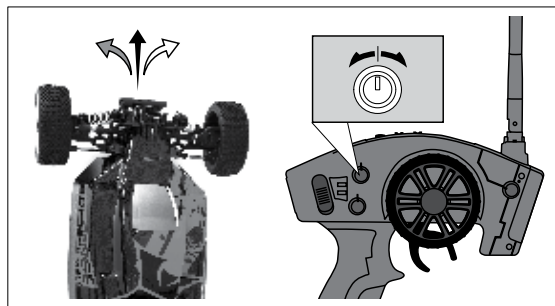

OPERATION

- ALWAYS turn on your transmitter before you turn on the receiver in the vehicle. Always power off the receiver before turning your transmitter off.
- ALWAYS operate your vehicle in a wide open area. Operating the vehicle in a small space or indoors can cause overheating at low speeds. Operating at low speed increases heat in the electronic speed control (ESC). Overheating can damage the vehicle and failure may result.
- Maintain sight of the vehicle at all times.
- Inspect the vehicle for loose wheel hardware.
- Inspect the steering assembly for any loose hardware. Driving the vehicle off-road can cause fasteners to loosen over time.
- Do not drive the vehicle in tall grass. Doing so can damage the vehicle or electronics.
- Stop driving the vehicle when you notice a lack of power.

CAUTION: Do not discharge a Li-Po battery below 3V per cell. Batteries discharged to a voltage lower than the lowest approved voltage may become damaged, resulting in loss of performance and potential fire when batteries are charged.

CAUTION: Using Li-Po batteries while the ESC is in Ni-MH mode may over discharge the cells. Ensure the ESC is in Li-Po mode when using Li-Po batteries.

- Do not apply the throttle in forward or reverse if the vehicle is stuck. Applying throttle in this instance can damage the motor or ESC.
- After driving the vehicle, allow the electronics to cool to ambient temperature before using the next battery pack.

Run Time

The largest factor in run time is the capacity of the battery pack. A larger mAh rating increases the amount of run time experienced. The condition of a battery pack is also an important factor in both run time and speed. The battery connectors may become hot during driving. Batteries will lose performance and capacity over time. Driving the vehicle from a stop to full speed repeatedly will damage the batteries and electronics over time. Sudden acceleration will also lead to shorter run times.

To improve run times:

- Keep your vehicle clean and maintained.
- Allow more airflow to the ESC and Motor by adding vents and cooling holes to the body.
- Drive with smooth application of throttle and brake input. Avoid "Jack Rabbit" type driving.
- Use a lower timing setting on the ESC.
- Change the gearing to a lower ratio. A lower ratio lowers the operating temperature of the electronics. Use a smaller pinion gear or larger spur gear to lower the gear ratio.
- Ensure that the gear mesh is set properly.
- Use a battery pack with a higher mAh rating.
- Use the optimum charger to charge battery packs.

Visit your local hobby dealer for more information.

WHEN YOU ARE FINISHED

1. Remove the body.



2. Power off the ESC and disconnect the battery.

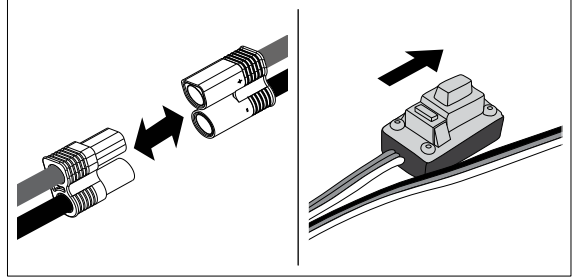

3. Power off the transmitter.

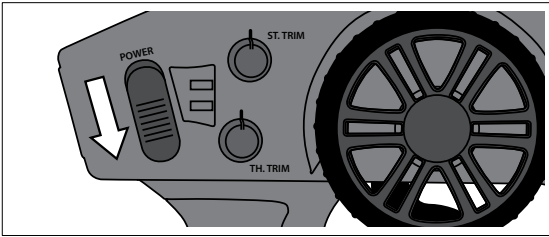

4. Remove the battery from the vehicle and recharge the battery.

MOTOR CARE

- Prolong motor life by preventing overheating conditions. Undue motor wear results from frequent turns, stops and starts, pushing objects, driving in deep sand and tall grass, and driving continuously up hill.
- Over-temperature protection is installed on the ESC to prevent circuit damage, but cannot protect the motor from driving against heavy resistance.

MAINTENANCE

SETTING THE GEAR MESH

The gear mesh has already been set at the factory. Setting the gear mesh is only necessary when changing motors or gears.

Proper gear mesh (how the gear teeth meet) is important to the performance of the vehicle. When the gear mesh is too loose, the spur and pinion gears could be damaged. If the mesh is too tight, speed could be limited and the motor and ESC will overheat.

Set the gear mesh by following these simple steps:

1. Loosen the 2 motor screws.
2. Put a small piece of paper (**A**) between the pinion and spur gears.
3. Push the gears together while tightening the motor screws.
4. Rotate the gears to remove the paper. The gearing should move a small amount.

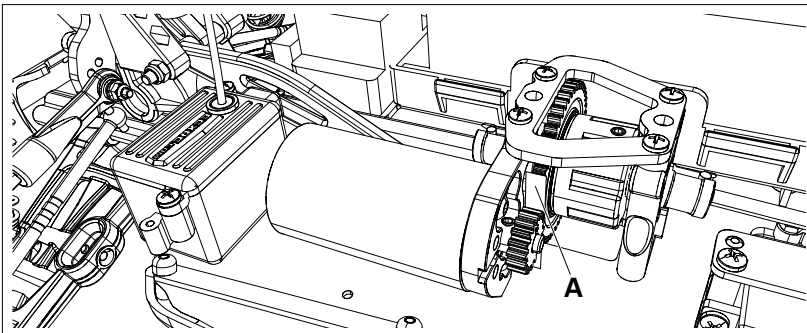

ELECTRONIC SPEED CONTROL (ESC)

The ESC comes preset from the factory. It will need to be recalibrated whenever changing to a different transmitter.

ESC Calibration Procedure

Ensure proper ESC function by calibrating the ESC to your transmitter inputs.

1. Power off the ESC.
2. Ensure your transmitter is powered on, the throttle is not reversed, throttle trim is neutral and throttle travel range is at 100%. Disable any special functions such as ABS, etc.
3. Press the SET button **(A)** while powering on the ESC. Release the button as soon as the red LED starts to flash.
4. Calibrate the throttle points by pressing the SET button once after each step.
 - Neutral point (1 flash) - leave the throttle at rest, untouched
 - Full throttle (2 flashes) - pull the throttle fully back
 - Full brakes/reverse (3 flashes) - push the throttle fully forward
5. The motor will run 3 seconds after the last step is completed.

Tip: If the motor turns in the wrong direction, reverse the connection of any 2 motor wires.

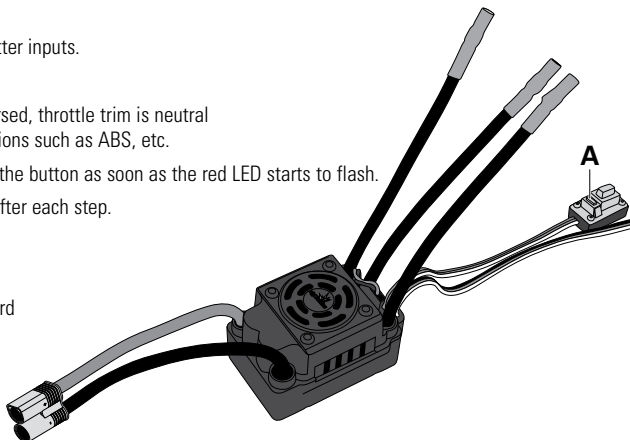

ESC Functions and Modes

The Fuze™ ESC includes programming options so you can adjust the way your vehicle performs. Refer to the included settings table to adjust the ESC for your driving conditions.

ESC Programming Procedure

Programmable items 1–9 are accessed through the SET button **(A)**. Programmable items 10–13 require the Digital Program Box (DYN3748).

1. Connect a battery to the ESC.
2. Power on the ESC using the ESC switch.
3. Hold the SET button for 1 second until the green LED blinks, then release the SET button to enter programming mode.
4. Press and release the SET button as needed to get to the desired menu option (the Green LED will blink corresponding to the menu item number). Programming menu items 1 through 9 are accessible using the SET button on the ESC. Programming menu items 10 and

above are only accessible using the optional ESC programming card. Programming of menu items 10 and 11 is only possible after firmware updates to the ESC programming card.

5. When at the desired menu item, hold the SET button for 3 seconds until the red LED blinks.
6. Press the SET button to move among the settings based on how many times the red LED blinks (Refer to the table for more information).
7. Save the setting by holding the SET button for 3 seconds.
8. Power off the ESC switch and repeat instructions above to change other settings.

Tip: If desired, the ESC programming can be returned to default settings by powering on the ESC switch and holding the SET button for 5 seconds.

| | | Programmable Value | | | | | | | | |
|----------------|----|------------------------------|--------------------|----------------------------|-----------------|-----------|-----------|-----------|---------|---------|
| | | 1 | 2 | 3 | 4 | 5 | 6 | 7 | 8 | 9 |
| Basic Items | 1 | Running Mode | Forward with Brake | Forward/Reverse with Brake | Forward/Reverse | | | | | |
| | 2 | Drag Brake Force | 0% | 5% | 10% | 20% | 40% | 60% | 80% | 100% |
| | 3 | Low Voltage Cutoff Threshold | non-protection | 2.6V/Cell | 2.8V/Cell | 3.0V/Cell | 3.2V/Cell | 3.4V/Cell | | |
| | 4 | Start Mode | Level 1 | Level 2 | Level 3 | Level 4 | Level 5 | Level 6 | Level 7 | Level 8 |
| Advanced Items | 5 | Max Brake Force | 25% | 50% | 75% | 100% | disable | | | |
| | 6 | Max Reverse Force | 25% | 50% | 75% | 100% | | | | |
| | 7 | Initial Brake Force | = Drag Brake Force | 0% | 20% | 40% | | | | |
| | 8 | Neutral Range | 6% (Narrow) | 9% (Normal) | 12% (Wide) | | | | | |
| | 9 | Timing | 0.00° | 3.75° | 7.50° | 11.25° | 15.00° | 18.75° | 22.50° | 26.25° |
| | 10 | Reserved Item | | | | | | | | |
| | 11 | Reserved Item | | | | | | | | |
| | 12 | Motor Rotation | Counter-clockwise | Clockwise | | | | | | |
| | 13 | Li-Po Cells | Auto Calculate | 2 Cells | 3 Cells | | | | | |

SHOCK CLEANING

Oil-filled shocks will require regular maintenance due to the oil breaking down or getting dirty. This maintenance should be performed after about every 3 to 5 hours of use, depending on the conditions that the vehicle is used in.

- Remove the shock from the vehicle.
- Remove the cap from the shock body and dispose of fluid.
- Disassemble the shock. Clean thoroughly with DYN5505. Dry parts before assembly.
- Re-assemble the shock and refill the shock body with silicone fluid (40 weight recommended for front shocks, 30 weight recommended for rear shocks).
- Slowly move the shaft and piston up and down to remove air bubbles.
- Move the piston to the midway point of the body and install the cap.

- Wipe off any overflowing fluid.
- When properly filled, the piston should rebound about 3/8 in (9.5mm) after being pushed in fully.
- Re-install the shock on the vehicle.

Ride Height Adjustment

In order to check for proper standard baseline ride height, drop the vehicle from about 6 in above a level work area. After the vehicle settles, both the front and rear suspension arms should be parallel with the surface. The ride height is adjusted by adding or removing the included spring pre-load clips.

Lowering the front ride height increases steering, but decreases traction. Lowering the rear ride height increases traction, but decreases steering.

ADDITIONAL MAINTENANCE TIPS

- Examine your vehicle on a regular basis.
- Use a brush to remove dirt and dust.
- Look for damage to the suspension arms around other molded parts.
- Re-glue the tires to the wheels, if necessary.
- Use suitable tools to check and tighten fasteners.
- Make sure the camber and steering linkages are not bent. Replace any bent linkages.
- Adjust the Toe and Camber settings, if necessary.
- Remove the shocks and inspect them for damage. Rebuild the shocks on a regular basis or if oil is leaking.

- Inspect the electronics and batteries for exposed wires. Repair exposed wires with shrink-wrap, or replace the wire.
- Make sure the ESC is secure on the chassis. Replace the double-sided tape, if necessary.
- Power on the transmitter. If the green LED is flashing, replace the AA batteries in your transmitter.
- Check the pinion and spur gear for wear.

Cleaning

Performance can be hindered if dirt gets in any of the moving suspension parts. Use compressed air, a soft paintbrush, or a toothbrush to remove dust or dirt. Avoid using solvents or chemicals as they can actually wash dirt into the bearings or moving parts, as well as cause damage to the electronics.

BINDING

Binding is the process of programming the receiver to recognize the GUID (Globally Unique Identifier) code of a single specific transmitter. The DX2E and SR200 are bound at the factory.

If you need to rebind, follow the instructions below.

1. With the receiver off, insert the bind plug into the BIND port on the receiver.
2. When a battery is connected to the ESC and the ESC is connected to the throttle port on the receiver, power on the ESC switch. An LED on the receiver will flash rapidly, showing the receiver is in Bind mode.
3. Do not touch the throttle or steering controls, as this sets the failsafe settings. The throttle and throttle trim should always be at the lowest setting during bind mode. Press and hold the bind button and power on the transmitter. The green LED on the front of the transmitter will flash within three seconds, indicating the transmitter is in bind mode.
4. Release the bind button when the green LED flashes.

Bind Button



5. The receiver's LED will turn solid when the transmitter and receiver are bound.
6. Remove the bind plug and store it in a convenient place.

You must rebind when:

- Different failsafe positions are desired e.g., when throttle or steering reversing has been changed.
- Changing receiver types e.g., changing from a DSM[®] receiver to a DSM2[®], DSMR[™] or Marine receiver.
- Binding the receiver to a different transmitter.

Some Spektrum receivers, like the SR3001, use a bind button rather than a bind plug. The binding process is the same with this receiver, however, instead of inserting the plug before powering up the receiver, press and hold the bind button while powering up the receiver to enter bind mode.

Failsafe

In the unlikely event that the radio link is lost during use, the receiver will drive the servos to their preprogrammed failsafe positions (normally neutral/idle throttle position and straight steering). If the receiver is turned on prior to turning on the transmitter, the receiver will enter failsafe mode. When the transmitter is turned on, normal control is resumed. Failsafe servo positions are set during binding (see BINDING).

TROUBLESHOOTING GUIDE

| Problem | Possible Cause | Solution |
|---|--|---|
| Short Run Time | <ul style="list-style-type: none"> • Battery damaged/not charged • Bind in drivetrain • Aggressive driving style • High drag driving environment • Over-geared | <ul style="list-style-type: none"> • Check/change battery • Clean/adjust • Apply throttle and brakes more smoothly • Drive on a smoother and harder surface • Install a smaller pinion |
| Sluggish Action | <ul style="list-style-type: none"> • Bind in drivetrain • Vehicle battery is not charged | <ul style="list-style-type: none"> • Clean/adjust • Replace/recharge |
| Controls Reversed | <ul style="list-style-type: none"> • ST. REV or TH. REV | <ul style="list-style-type: none"> • Change switch position |
| Motor/ESC overheat | <ul style="list-style-type: none"> • Over-geared • ESC fan not operating | <ul style="list-style-type: none"> • Install smaller pinion • Add additional cooling vents to body • Check connections/replace |
| Doesn't Operate | <ul style="list-style-type: none"> • Transmitter batteries low • Transmitter powered off • ESC powered off • Vehicle battery is not charged • Motor leads not connected • Receiver not bound | <ul style="list-style-type: none"> • Replace/recharge • Power On • Power On • Replace/recharge • Connect motor leads • Bind the receiver |
| Poor Range | <ul style="list-style-type: none"> • Transmitter batteries low • Transmitter antenna is damaged • Receiver antenna damaged | <ul style="list-style-type: none"> • Replace/recharge • Replace • Check/repair/replace |
| The system will not connect | <ul style="list-style-type: none"> • Transmitter and receiver too near each other • Transmitter and receiver too near large metal objects (vehicles, etc.) • Transmitter accidentally put in bind mode; receiver is no longer bound | <ul style="list-style-type: none"> • Move transmitter 8–12 feet (2.4–3.6m) from receiver • Move away from large metal objects (vehicles, etc.) • Rebind transmitter and receiver |
| The receiver goes into failsafe mode a short distance away from the transmitter | <ul style="list-style-type: none"> • Check the receiver antenna to ensure it is not cut or damaged | <ul style="list-style-type: none"> • Contact Horizon Product Support • Make sure receiver antenna is in an antenna tube and is above vehicle |
| The receiver quits responding during operation | <ul style="list-style-type: none"> • Low battery voltage • Loose or damaged wires or connectors between battery and receiver | <ul style="list-style-type: none"> • Completely recharge battery • Do a check of the wires and connection between battery and receiver. Repair or replace wires and/or connectors |

LIMITED WARRANTY

What this Warranty Covers

Horizon Hobby, LLC (Horizon) warrants to the original purchaser that the product purchased (the "Product") will be free from defects in materials and workmanship at the date of purchase.

What is Not Covered

This warranty is not transferable and does not cover (i) cosmetic damage, (ii) damage due to acts of God, accident, misuse, abuse, negligence, commercial use, or due to improper use, installation, operation or maintenance, (iii) modification of or to any part of the Product, (iv) attempted service by anyone other than a Horizon Hobby authorized service center, (v) Product not purchased from an authorized Horizon dealer, or (vi) Product not compliant with applicable technical regulations.

OTHER THAN THE EXPRESS WARRANTY ABOVE, HORIZON MAKES NO OTHER WARRANTY OR REPRESENTATION, AND HEREBY DISCLAIMS ANY AND ALL IMPLIED WARRANTIES, INCLUDING, WITHOUT LIMITATION, THE IMPLIED WARRANTIES OF NON-INFRINGEMENT,

MERCHANTABILITY AND FITNESS FOR A PARTICULAR PURPOSE. THE PURCHASER ACKNOWLEDGES THAT THEY ALONE HAVE DETERMINED THAT THE PRODUCT WILL SUITABLY MEET THE REQUIREMENTS OF THE PURCHASER'S INTENDED USE.

Purchaser's Remedy

Horizon's sole obligation and purchaser's sole and exclusive remedy shall be that Horizon will, at its option, either (i) service, or (ii) replace, any Product determined by Horizon to be defective. Horizon reserves the right to inspect any and all Product(s) involved in a warranty claim. Service or replacement decisions are at the sole discretion of Horizon. Proof of purchase is required for all warranty claims. SERVICE OR REPLACEMENT AS PROVIDED UNDER THIS WARRANTY IS THE PURCHASER'S SOLE AND EXCLUSIVE REMEDY.

Limitation of Liability

HORIZON SHALL NOT BE LIABLE FOR SPECIAL, INDIRECT, INCIDENTAL OR CONSEQUENTIAL DAMAGES, LOSS OF PROFITS OR PRODUCTION OR COMMERCIAL LOSS IN ANY WAY, REGARDLESS OF WHETHER

SUCH CLAIM IS BASED IN CONTRACT, WARRANTY, TORT, NEGLIGENCE, STRICT LIABILITY OR ANY OTHER THEORY OF LIABILITY, EVEN IF HORIZON HAS BEEN ADVISED OF THE POSSIBILITY OF SUCH DAMAGES. Further, in no event shall the liability of Horizon exceed the individual price of the Product on which liability is asserted. As Horizon has no control over use, setup, final assembly, modification or misuse, no liability shall be assumed nor accepted for any resulting damage or injury. By the act of use, setup or assembly, the user accepts all resulting liability. If you as the purchaser or user are not prepared to accept the liability associated with the use of the Product, purchaser is advised to return the Product immediately in new and unused condition to the place of purchase.

Law

These terms are governed by Illinois law (without regard to conflict of law principals). This warranty gives you specific legal rights, and you may also have other rights which vary from state to state. Horizon reserves the right to change or modify this warranty at any time without notice.

WARRANTY SERVICES

Questions, Assistance, and Services

Your local hobby store and/or place of purchase cannot provide warranty support or service. Once assembly, setup or use of the Product has been started, you must contact your local distributor or Horizon directly. This will enable Horizon to better answer your questions and service you in the event that you may need any assistance. For questions or assistance, please visit our website at www.horizonhobby.com, submit a Product Support Inquiry, or call the toll free telephone number referenced in the Warranty and Service Contact Information section to speak with a Product Support representative.

Inspection or Services

If this Product needs to be inspected or serviced and is compliant in the country you live and use the Product in, please use the Horizon Online Service Request submission process found on our website or call Horizon to obtain a Return Merchandise Authorization (RMA) number. Pack the Product securely using a shipping carton. Please note that original boxes may be included, but are not designed to withstand the rigors of shipping without additional protection. Ship via a carrier that provides tracking and insurance for lost or damaged parcels, as Horizon is not responsible for merchandise until it arrives and is accepted at our facility. An Online Service Request is available at http://www.horizonhobby.com/content/_service-center_render-service-center.

Contact Information

| Country of Purchase | Horizon Hobby | Contact Information | Address |
|--------------------------|---|---|--|
| United States of America | Horizon Service Center (Repairs and Repair Requests) | servicecenter.horizonhobby.com/ RequestForm/ | 4105 Fieldstone Rd Champaign, Illinois, 61822 USA |
| | Horizon Product Support (Product Technical Assistance) | www.quickbase.com/db/ bghj7ey8c?a=GenNewRecord 888-959-2306 | |
| | Sales | sales@horizonhobby.com 888-959-2306 | |
| United Kingdom | Service/Parts/Sales: Horizon Hobby Limited | sales@horizonhobby.co.uk +44 (0) 1279 641 097 | Units 1-4 , Ployters Rd, Staple Tye Harlow, Essex, CM18 7NS, United Kingdom |
| Germany | Horizon Technischer Service Sales: Horizon Hobby GmbH | service@horizonhobby.de +49 (0) 4121 2655 100 | Christian-Junge-Straße 1 25337 Elmshorn, Germany |
| France | Service/Parts/Sales: Horizon Hobby SAS | infofrance@horizonhobby.com +33 (0) 1 60 18 34 90 | 11 Rue Georges Charpak 77127 Lieusaint, France |
| China | Service/Parts/Sales: Horizon Hobby – China | info@horizonhobby.com.cn +86 (021) 5180 9868 | Room 506, No. 97 Changshou Rd. Shanghai, China 200060 |

If you do not have internet access, please contact Horizon Product Support to obtain a RMA number along with instructions for submitting your product for service. When calling Horizon, you will be asked to provide your complete name, street address, email address and phone number where you can be reached during business hours. When sending product into Horizon, please include your RMA number, a list of the included items, and a brief summary of the problem. A copy of your original sales receipt must be included for warranty consideration. Be sure your name, address, and RMA number are clearly written on the outside of the shipping carton.

NOTICE: Do not ship Li-Po batteries to Horizon. If you have any issue with a Li-Po battery, please contact the appropriate Horizon Product Support office.

Warranty Requirements

For Warranty consideration, you must include your original sales receipt verifying the proof-of-purchase date. Provided warranty conditions have been met, your Product will be serviced or replaced free of charge. Service or replacement decisions are at the sole discretion of Horizon.

Non-Warranty Service

Should your service not be covered by warranty, service will be completed and payment will be required without notification or estimate of the expense unless the expense exceeds 50% of the retail purchase cost. By submitting the item for service you are agreeing to payment of the service without notification. Service estimates are available upon request. You must include this request with your item submitted for service. Non-warranty service estimates will be billed a minimum of ½ hour of labor. In addition you will be billed for return freight. Horizon accepts money orders and cashier's checks, as well as Visa, MasterCard, American Express, and Discover cards. By submitting any item to Horizon for service, you are agreeing to Horizon's Terms and Conditions found on our website http://www.horizonhobby.com/content/_service-center_render-service-center.

ATTENTION: Horizon service is limited to Product compliant in the country of use and ownership. If received, a non-compliant Product will not be serviced. Further, the sender will be responsible for arranging return shipment of the un-serviced Product, through a carrier of the sender's choice and at the sender's expense. Horizon will hold non-compliant Product for a period of 60 days from notification, after which it will be discarded.

FCC INFORMATION

This device complies with part 15 of the FCC rules. Operation is subject to the following two conditions: (1) This device may not cause harmful interference, and (2) this device must accept any interference received, including interference that may cause undesired operation.

CAUTION: Changes or modifications not expressly approved by the party responsible for compliance could void the user's authority to operate the equipment.

This product contains a radio transmitter with wireless technology which has been tested and found to be compliant with the applicable regulations governing a radio transmitter in the 2.400GHz to 2.4835GHz frequency range.

Antenna Separation Distance

When operating your Spektrum transmitter, please be sure to maintain a separation distance of at least 5 cm between your body (excluding fingers, hands, wrists, ankles and feet) and the antenna to meet RF exposure safety requirements as determined by FCC regulations.

The following illustrations show the approximate 5 cm RF exposure area and typical hand placement when operating your Spektrum transmitter.

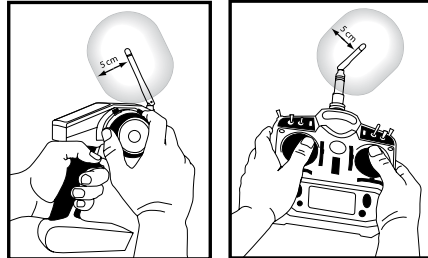

IC INFORMATION

This device complies with Industry Canada license-exempt RSS standard(s). Operation is subject to the following two conditions: (1) this device may not cause interference, and (2) this device must accept any interference, including interference that may cause undesired operation of the device.

COMPLIANCE INFORMATION FOR THE EUROPEAN UNION

| | | | | | | |
|----|----|----|----|----|----|----|
| AT | BE | BG | CZ | CY | DE | DK |
| EE | ES | FI | FR | GR | HR | HU |
| IE | IT | LT | LU | LV | MT | NL |
| PL | PT | RO | SE | SI | SK | UK |
| IS | LI | NO | CH | | | |

CE **!** **Declaration of Conformity**
(in accordance with ISO/IEC 17050-1)

No. HH2014060201

Product(s): Revenge Type-E 1:8 4WD BX BL: R/B (Spektrum DX2E transmitter and SR410 receiver included)

Item Number(s): ECX04000

Equipment class: 2

The object of declaration described above is in conformity with the requirements of the specifications listed below, following the provisions of the European R&TTE directive 1999/5/EC, EMC Directive 2004/108/EC and LVD Directive 2006/95/EC:

EN 300-328 V1.7.1: 2006

EN301 489-1 V1.9.2: 2012

EN301 489-17 V2.1.1: 2009

EN60950-1:2006+A11:2009+A1:2010+A12: 2011

EN55022:2010 + AC:2011

EN55024:2010

Signed for and on behalf of:
Horizon Hobby, LLC
Champaign, IL USA
June 2, 2014

Robert Peak
Chief Financial Officer
Horizon Hobby, LLC



**Instructions for disposal of WEEE
by users in the European Union**

This product must not be disposed of with other waste. Instead, it is the user's responsibility to dispose of their waste equipment by handing it over to a designated collections point for the recycling of waste electrical and electronic equipment. The separate collection and recycling of your waste equipment at the time of disposal will help to conserve natural resources and ensure that it is recycled in a manner that protects human health and the environment. For more information about where you can drop off your waste equipment for recycling, please contact your local city office, your household waste disposal service or where you purchased the product.